



Better tools Better Life

Safe and Energy-Saving
Flexible Travel



ShangHai TEKWAY Catalog

**Car Rental
Company Brochure**

目录

TABLE OF
CONTENTS

01

Company Profile

公司简介

02

Corporate Culture

企业文化

05

Car Cleaning

汽车清洁产品

06

Product Display

用户体验/售后

03

Car Detailing
汽车美容产品

04

Collision Repair
汽车修复产品

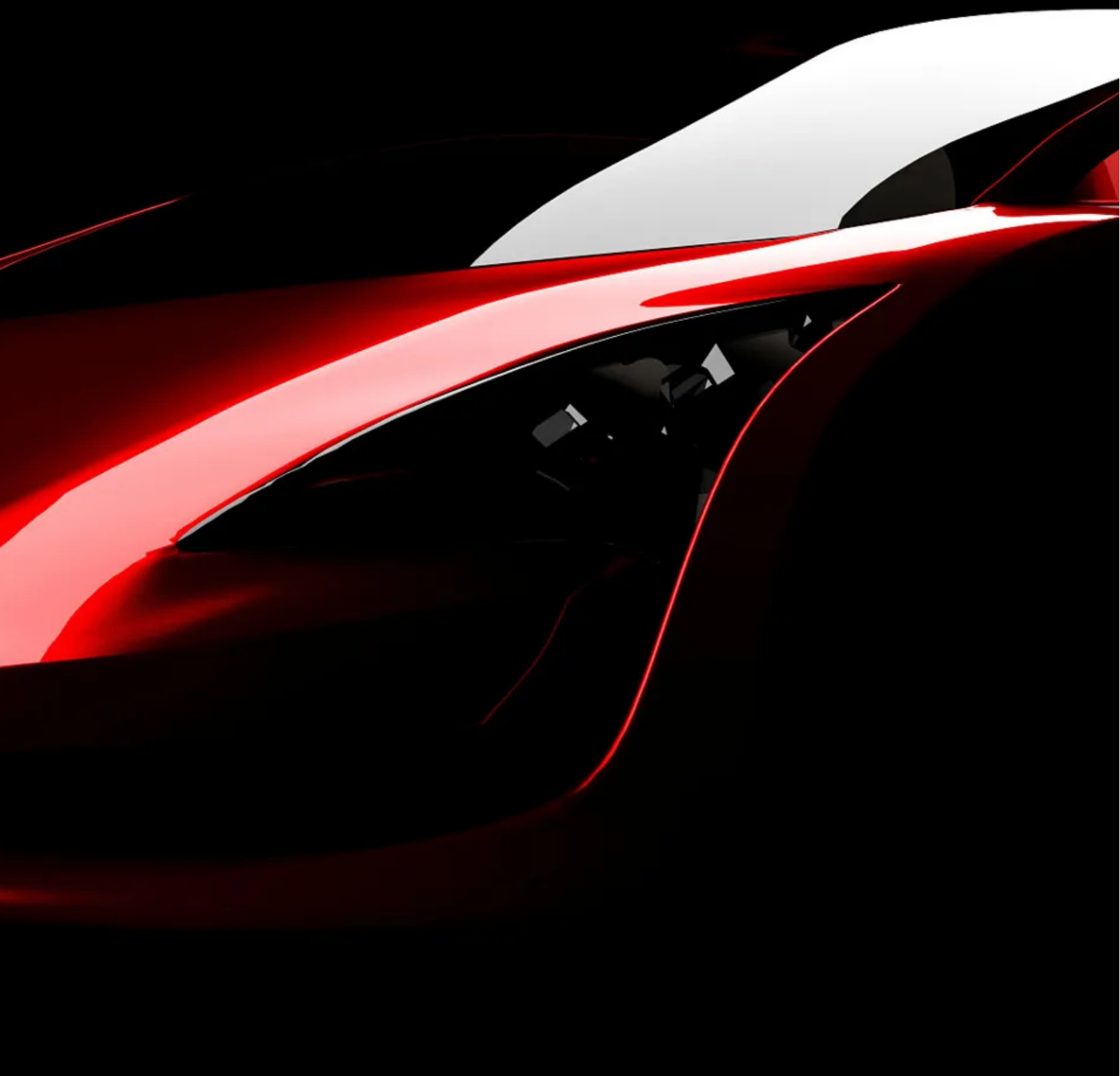



公司介绍

Company Profile

Shanghai techway industrial co.,ltd is located in the international metropolis Shanghai and was established in 2008. Its business scope includes car beauty, repair, and cleaning tools. Such as orbital car sanders, polishers, waxing machines, polishing pads, wool discs, pullers, welding guns, car jacks, cordless polishers, foam pads and other related products.

We have many long-term cooperative customers from the United States, Russia, Brazil, Ukraine, Indonesia, Philippines, Nigeria... Better tools, better life is our trade belief, reflected in our reception desk. Our purpose is to create a better life and a better place for you, for me, and for all mankind.

As an automotive detailing supplier, we have very strict procedures to control the quality and production of each product. Our engineers and QC have been working in our factory for more than 10 years. They have extensive experience with the product. Raw materials are selected from more than 10-20 potential suppliers. Qualified suppliers must be approved by documents, licenses, physical workplace inspections and approved suppliers. Ensure consistency in order retention for customers.



企业文化

Corporate Culture

Responsible

Responsibility is one of our core values. We are built on integrity and commitment and consistently deliver on our promises to our customers, employees and partners. We understand the importance of responsibility and integrate it into our work and decision-making

Integrity

Our company's culture is based on sincerity and integrity. We believe that sincere communication and honest behavior are the keys to building good relationships. We treat every employee, customer and partner with respect and care, and always maintain a transparent and open attitude. Establish long-term partnerships based on credit.

Professional

Our company's success stems from our commitment to our customers. We use our professional knowledge and experience to provide customers with customized solutions. We deeply understand our customers' business needs, work closely with them, and provide high-quality products and services.

业务架构

Organizational Structure

TOP sales

The sales department is committed to providing customers with excellent products and services. We have a sales team full of passion and expertise, who deeply understand customer needs and provide customized solutions.



Market purchasing

The market purchasing department is responsible for finding and purchasing high-quality raw materials and products. We establish cooperative relationships with reliable suppliers and constantly seek new cooperation opportunities.

Quality Inspection

With a high-quality quality control team, they strictly control every production link to ensure that the products meet the highest quality standards. Adopt advanced testing equipment and technology to conduct comprehensive quality inspection and testing.



资质荣誉

Qualification and Honor

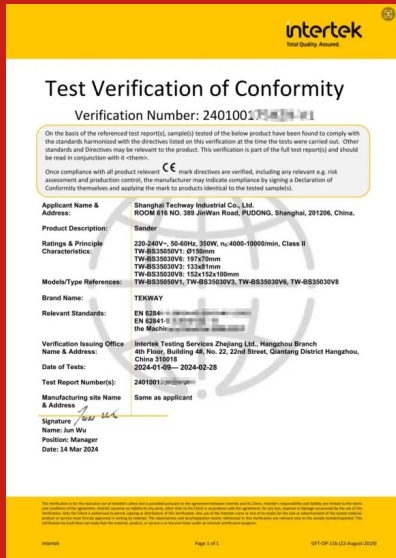

CE certificate



Brand certificate



Brand certificate



TUV certification certificate

Car Detailing

汽车美容系列

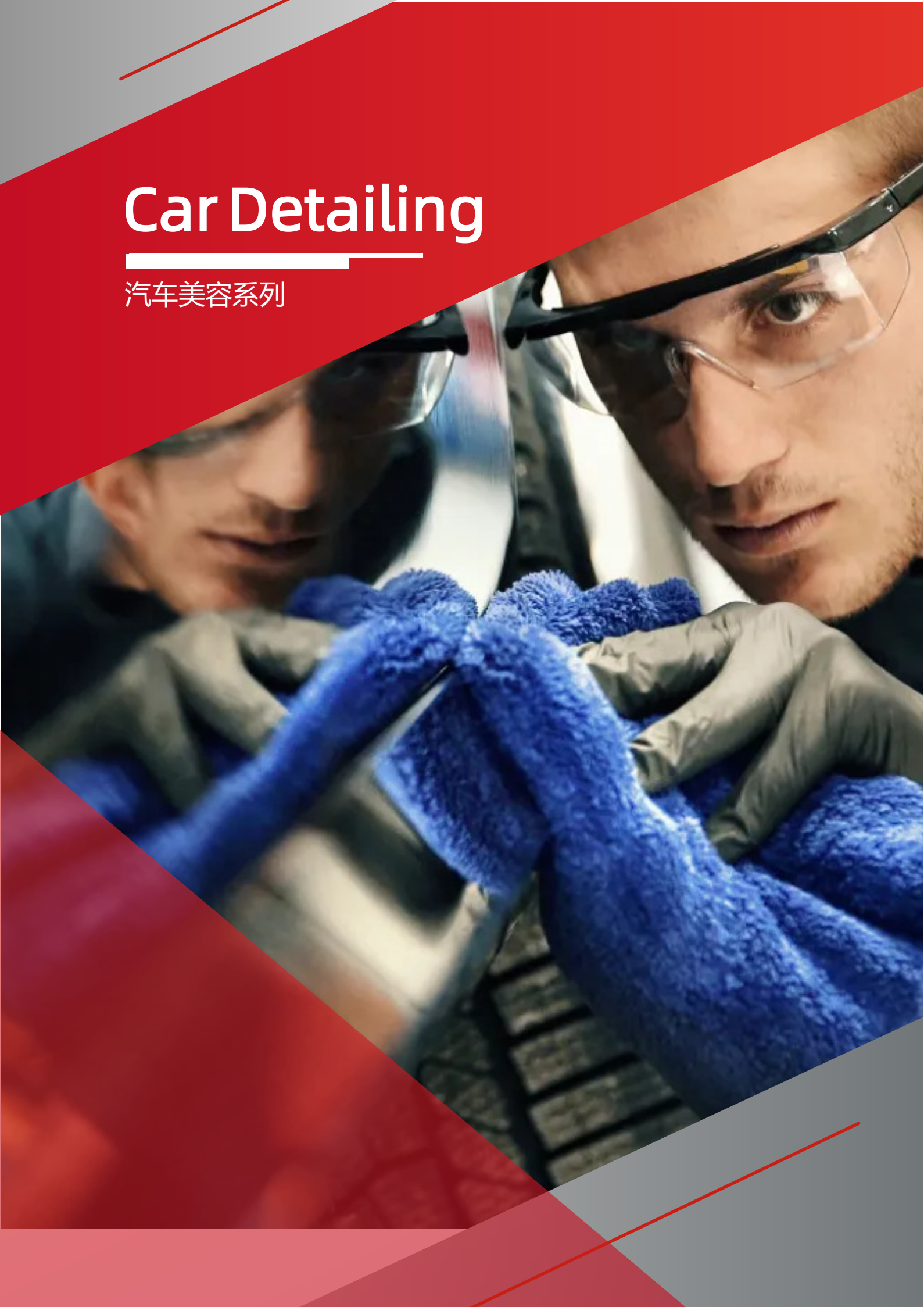



New TEKWAY® Sander is designed for sanding windows, doors and frames and performing correction work on wood filler.



Low profile and large size ideal for sanding with TEKWAY® Sander to treat large areas.



The compact TEKWAY® Sander is ideal for body filler and primer sanding applications.

The TEKWAY® Brushless Sander is a great helper on the job offers fast, efficient and dust-free sanding performance.

key features

- Powerful and great performance
- The compact and low profile gives full control over the work
- The sanding machine can start and stop synchronously with the vacuum cleaner
- The ergonomic design makes it comfortable to use for long periods



Technicals	Tekway® TW_50V1BS	Tekway® TW_30V8BS	Tekway® TW_30V6BS	Tekway® TW_30V3BS
Code	TID150-006	TID35050-Z005	TID125150-002	TID230612-0538
Size	125/150mm(5/6 inch)	100*152*152mm	70*197mm	81*133mm
Mains frequency	50/60 Hz	50/60 Hz	50/60 Hz	50/60 Hz
Power input	350W	350W	350W	350W
Mains voltage	220-240VAC	220-240VAC	220-240VAC	220-240VAC
Speed	4000- 10000r/min	4000- 10000r/min	4000-10000 r/min	4000-10000 r/min
Orbit	2.5/5.0/8.0 mm	3.0 mm	3.0mm	3.0mm
Weight	970g	970g	970g	900g
Height	101mm	101mm	101mm	101mm
Noise level LpA	69 db(A)	69 db(A)	71db(A)	71 db(A)
Vibration level	2.6 m/s ²	2.6 m/s ²	2.6 m/s ²	2.6m/s ²
Size of pad	125/150mm	100*152*152mm	70*197mm	81*133 mm
Dust system	synchronous vacuum cleaner	synchronous vacuum cleaner	synchronous vacuum cleaner	synchronous vacuum cleaner
Packaging	cardboard box(OEM)	cardboard box	cardboard box	cardboard box



New TEKWAY® Sander The random orbital sander developed for effective and dust-free of all kind of surface.



The smallest and most ergonomic sander is equipped with a brushless motor, which maintains constant speed even under heavy load. TEKWAY® Sander to treat large areas.

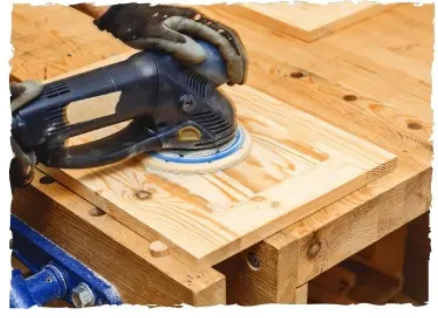

TEKWAY® Sander With the lowest vibration values and the unique symmetrical design guarantees that the tool can be used for long periods without fatigue.

The TEKWAY® Brushless Sander is a great helper on the job offers fast, efficient and dust-free sanding performance.

key features

- Powerful and great performance
- The compact and low profile gives full control over the work
- The sanding machine can start and stop synchronously with the vacuum cleaner
- The ergonomic design makes it comfortable to use for long periods



Technicals	TW-BS35050-0004	TW-BS35050-0005	Tekway® TW_004BS
Code	TID150-007	TID35050-Z009	TID150-006
Size	100X150mm	80 x 133 mm	70 x 198 mm (3 x 8")
Mains frequency	50/60 Hz	50/60 Hz	50/60 Hz
Power input	350W	350W	350W
Mains voltage	100-240VAC	100-240VAC	100-240VAC
Speed	4000- 10000r/min	4000- 10000r/min	4000- 10000r/min
Orbit	3.0mm	3.0 mm	3.0mm
Weight	970g	970g	1000g
Height	101mm	101mm	101mm
Noise level LpA	69 db(A)	69 db(A)	71 db(A)
Vibration level	2.6 m/s ²	2.6 m/s ²	3.3 m/s ²
Size of pad	100X150mm	80 x 133 mmmm	70 x 198 mm
Dust system	synchronous vacuum cleaner	synchronous vacuum cleaner	synchronous vacuum cleaner
Packaging	cardboard box(OEM)	cardboard box	cardboard box

➔ CAR VACUUM CLEANER



TW-VC18K30L Square vacuum cleaner

The vacuum cleaner is for wet and dry use with a blower function; the machine has two independent dust collection chambers, which are divided into an upper dust bucket and a lower dust bin (the upper dust bucket mainly requires coarse-grained dust or garbage), and the lower dust bucket can be filled with water. Filter the air again before it is discharged. The machine has a button to mechanically shake dust, and a manual button is required to trigger the cleaning of the filter element.

Rated power:	1600W	Tank Material:	PP
Rated voltage:	230V/50Hz	Hose DIA:	32mm
Vacuum:	>18Kpa	Plug:	VDE plug
Noise:	<78db	G.W:	18.1KG
Capacity:	30L	Power Cord length:	5M



Vacuum cleaner



Rated power:	1600W	Tank Material:	PP
Rated voltage:	220-240V/ 50/60Hz	Hose DIA:	32mm
Vacuum:	>20Kpa	Plug:	VDE plug
Noise:	<82db	G.W:	16.5KG
Capacity:	40L	Power Cord length:	5M

model: TSW-VC26K50L



1. professional dry vacuum cleaner with automatic filter shacking for solving the ultrafine dust working with power tools together
2. M class filtration system
3. with big rear wheels and big front wheels make it more stable in moving
4. with standard electrical socket for automatic synchronization function/ and optional puenmatic/ battery tools automatic synchronization working
5. professional 2 fans copper motor with longer life
6. big folding HEPA to protect the motor
7. wet /dry/blower function
8. indication automatic cut off power when water is full
9. hose collection on vacuum
10. optional tool box brackets

TSW-VC26K50L

Gas flow: 4500L/min

Vacuum degree: 2600pa

Filter area: 18133cm²

Power: 2300W

Filtration efficiency: 99%

Maximum volume: 50L

Wire length: 5m



TSW-VC20K38L

● High-end series

Maximum load: 2400w

Maximum suction power: 3900L/min

Power consumption: 800 W \pm 10%

Rated voltage: 230V/50Hz

Noise: <78db

Capacity: 38/36L

Tank Material: PP

Hose DIA: 32mm

Weight: 15kg

Plug: VDE plug

Power Cord length: 8m



● Application areas





Square vacuum cleaner

Working power supply: 220V/50Hz

Equipment power: 1200w

Maximum dust collection flow: 3900L/min

Maximum vacuum degree: >2400Pa

Filter area: 6800cm²

Working noise: <78dB

TW-VC24K42L

Small, powerful and extremely convenient: the TW-VC24K42L is designed for business users on the move and working with clients. The particularly compact design facilitates transport and loading of work equipment. The wet and dry vacuum cleaner is equipped with a semi-automatic filter cleaning system and meets EU "L" dust user protection standards. Professionals are freed from annoying dust at work.

TW-VC22K40L

Accessories:

- 1600W double stage copper motor;
- Visible 5.0m 3G1.5mm² power cable with VDE plug;
- 40L plastic body
- Adjustable blowing function;
- Foldable trolley handle;
- Cable storage function;
- 2000W socket with synchronization;
- Suction adjustment;
- Automatic filter-cleaning function;
- Triple filtration system + CLASSM.



Square vacuum cleaner

Rated power: 1600W
Rated voltage: 230V/50Hz
Vacuum: >22Kpa
Air flow: <2.1m³/min
Capacity: 40L
Tank Material: PP
Hose DIA: 32mm
Plug: VDE plug
Power Cord length: 4m

TW-VC20K30L

Accessories:

- 1pc metal floor brush + ganging buckle
- 1pc metal telescopic tube
- 2M hose
- 1pc plate filter
- 1pc dust paper bag
- 1pc small flat suction
- 1pc pagoda connector



Round vacuum cleaner

Rated power: 1600W
Rated voltage: 230V/50Hz
Vacuum: >20Kpa
Air flow: <2.1m³/min
Capacity: 30L
Tank Material: PP
Hose DIA: 32mm
Plug: VDE plug
Power Cord length: 4m

ABRASIVES

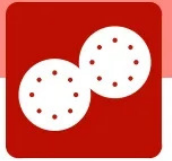

GRID SQUARE SANDPAPER

Art no.03.A001



Description

*MATERIAL: Aluminium oxide, semi-open coated, double resin binder, C-D paper backing.

APPLICATION: Specially recommended for auto-body work. Can be used on all unfinished and paint surfaces.

*FEATURES: Coated to prevent clogging.

*DISCS: Dia. 115mm, Dia. 125mm, Dia. 150mm, Dia. 180mm, Dia.230mm

*DELTA SHEETS: 76mm, 80mm, 93mm, 105mm

*STRIPES: 70×400mm, 93×230mm, 115×280mm, 280×230mm, 93x187 mm

Grit	80	100	120	150	180	220	240	280	320	360	400	500	600	800	1000
------	----	-----	-----	-----	-----	-----	-----	-----	-----	-----	-----	-----	-----	-----	------

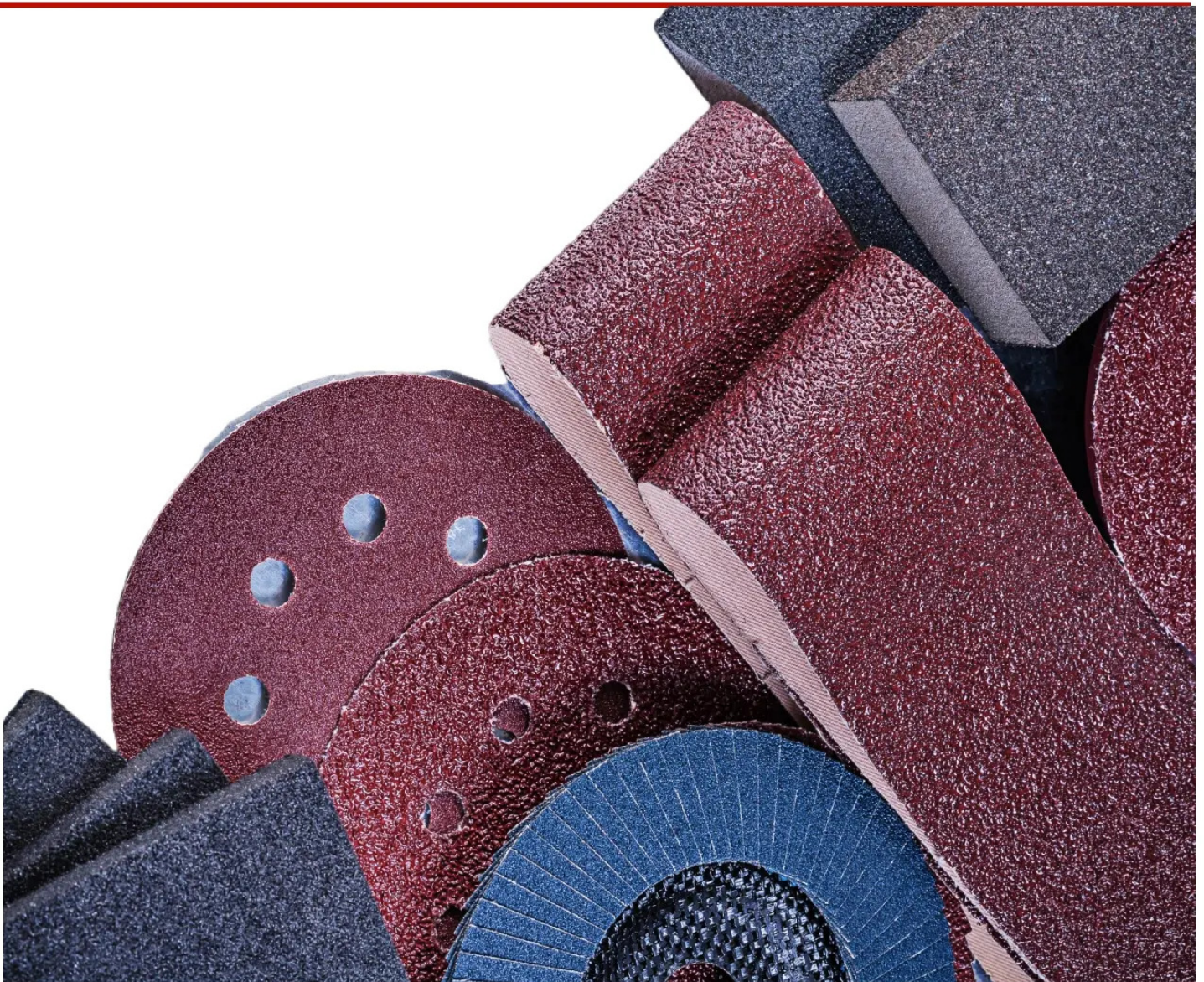



ABRASIVES

Ceramic Disc

Art no.01.A001



Description

*MATERIAL: Aluminium oxide, semi-open coated, double resin binder, C-D paper backing.

APPLICATION: Specially recommended for auto-body work. Can be used on all unfinished and paint surfaces.

"FEATURES: Coated to prevent clogging.

*DISCS: Dia. 115mm, Dia. 125mm, Dia. 150mm, Dia. 180mm, Dia.230mm

*DELTA SHEETS: 76mm, 80mm, 93mm, 105mm

*STRIPES: 70×400mm, 93×230mm, 115×280mm, 280×230mm, 93x187 mm

Grit	80	100	120	150	180	220	240	280	320	360	400	500	600	800	1000
------	----	-----	-----	-----	-----	-----	-----	-----	-----	-----	-----	-----	-----	-----	------

Gold Disc

Art no.01.A002



Description

*MATERIAL: Aluminium oxide, semi-open coated, double resin binder, C-D paper backing.

APPLICATION: Specially recommended for auto-body work. Can be used on all unfinished and paint surfaces.

"FEATURES: Coated to prevent clogging.

*DISCS: Dia. 115mm, Dia. 125mm, Dia. 150mm, Dia. 180mm, Dia.230mm

*DELTA SHEETS: 76mm, 80mm, 93mm, 105mm

*STRIPES: 70×400mm, 93×230mm, 115×280mm, 280×230mm, 93x187 mm

Grit	80	100	120	150	180	220	240	280	320	360	400	500	600	800	1000
------	----	-----	-----	-----	-----	-----	-----	-----	-----	-----	-----	-----	-----	-----	------

Film Disc

Art no.01.A003



Description

*MATERIAL: Aluminium oxide, semi-open coated, double resin binder, C-D paper backing.

APPLICATION: Specially recommended for auto-body work. Can be used on all unfinished and paint surfaces.

"FEATURES: Coated to prevent clogging.

*DISCS: Dia. 115mm, Dia. 125mm, Dia. 150mm, Dia. 180mm, Dia.230mm

*DELTA SHEETS: 76mm, 80mm, 93mm, 105mm

*STRIPES: 70×400mm, 93×230mm, 115×280mm, 280×230mm, 93x187 mm

Grit	80	100	120	150	180	220	240	280	320	360	400	500	600	800	1000
------	----	-----	-----	-----	-----	-----	-----	-----	-----	-----	-----	-----	-----	-----	------

ABRASIVES



VELCRO SANDING SPONGE

Art no.02.A001



Description

*MATERIAL: Aluminium oxide, semi-open coated, double resin binder, C-D paper backing.

APPLICATION: Specially recommended for auto-body work. Can be used on all unfinished and paint surfaces.

*FEATURES: Coated to prevent clogging.

*DISCS: Dia. 115mm, Dia. 125mm, Dia. 150mm, Dia. 180mm, Dia.230mm

*DELTA SHEETS: 76mm, 80mm, 93mm, 105mm

*STRIPES: 70×400mm, 93×230mm, 115×280mm, 280×230mm, 93x187 mm

Grit	80	100	120	150	180	220	240	280	320	360	400	500	600	800	1000
------	----	-----	-----	-----	-----	-----	-----	-----	-----	-----	-----	-----	-----	-----	------

VELCRO SANDING SPONGE

Art no.02.A002



Description

*MATERIAL: Aluminium oxide, semi-open coated, double resin binder, C-D paper backing.

APPLICATION: Specially recommended for auto-body work. Can be used on all unfinished and paint surfaces.

*FEATURES: Coated to prevent clogging.

*DISCS: Dia. 115mm, Dia. 125mm, Dia. 150mm, Dia. 180mm, Dia.230mm

*DELTA SHEETS: 76mm, 80mm, 93mm, 105mm

*STRIPES: 70×400mm, 93×230mm, 115×280mm, 280×230mm, 93x187 mm

Grit	80	100	120	150	180	220	240	280	320	360	400	500	600	800	1000
------	----	-----	-----	-----	-----	-----	-----	-----	-----	-----	-----	-----	-----	-----	------

WATER SANDPAPER

Art no.02.A003



Description

*MATERIAL: Aluminium oxide, semi-open coated, double resin binder, C-D paper backing.

APPLICATION: Specially recommended for auto-body work. Can be used on all unfinished and paint surfaces.

*FEATURES: Coated to prevent clogging.

*DISCS: Dia. 115mm, Dia. 125mm, Dia. 150mm, Dia. 180mm, Dia.230mm

*DELTA SHEETS: 76mm, 80mm, 93mm, 105mm

*STRIPES: 70×400mm, 93×230mm, 115×280mm, 280×230mm, 93x187 mm

Grit	80	100	120	150	180	220	240	280	320	360	400	500	600	800	1000
------	----	-----	-----	-----	-----	-----	-----	-----	-----	-----	-----	-----	-----	-----	------



ABRASIVES

Gold Disc

Art no.01.A004



Description

*MATERIAL: Aluminium oxide, semi-open coated, double resin binder, C-D paper backing.

APPLICATION: Specially recommended for auto-body work. Can be used on all unfinished and paint surfaces.

"FEATURES: Coated to prevent clogging.

*DISCS: Dia. 115mm, Dia. 125mm, Dia. 150mm, Dia. 180mm, Dia.230mm

*DELTA SHEETS: 76mm, 80mm, 93mm, 105mm

*STRIPES: 70×400mm, 93×230mm, 115×280mm, 280×230mm, 93x187 mm

Grit	80	100	120	150	180	220	240	280	320	360	400	500	600	800	1000
------	----	-----	-----	-----	-----	-----	-----	-----	-----	-----	-----	-----	-----	-----	------

ORIENT NET

Art no.01.A005



Description

*MATERIAL: Aluminium oxide, semi-open coated, double resin binder, C-D paper backing.

APPLICATION: Specially recommended for auto-body work. Can be used on all unfinished and paint surfaces.

"FEATURES: Coated to prevent clogging.

*DISCS: Dia. 115mm, Dia. 125mm, Dia. 150mm, Dia. 180mm, Dia.230mm

*DELTA SHEETS: 76mm, 80mm, 93mm, 105mm

*STRIPES: 70×400mm, 93×230mm, 115×280mm, 280×230mm, 93x187 mm

Grit	80	100	120	150	180	220	240	280	320	360	400	500	600	800	1000
------	----	-----	-----	-----	-----	-----	-----	-----	-----	-----	-----	-----	-----	-----	------

ORIENT NET

Art no.01.A006



Description

*MATERIAL: Aluminium oxide, semi-open coated, double resin binder, C-D paper backing.

APPLICATION: Specially recommended for auto-body work. Can be used on all unfinished and paint surfaces.

"FEATURES: Coated to prevent clogging.

*DISCS: Dia. 115mm, Dia. 125mm, Dia. 150mm, Dia. 180mm, Dia.230mm

*DELTA SHEETS: 76mm, 80mm, 93mm, 105mm

*STRIPES: 70×400mm, 93×230mm, 115×280mm, 280×230mm, 93x187 mm

Grit	80	100	120	150	180	220	240	280	320	360	400	500	600	800	1000
------	----	-----	-----	-----	-----	-----	-----	-----	-----	-----	-----	-----	-----	-----	------

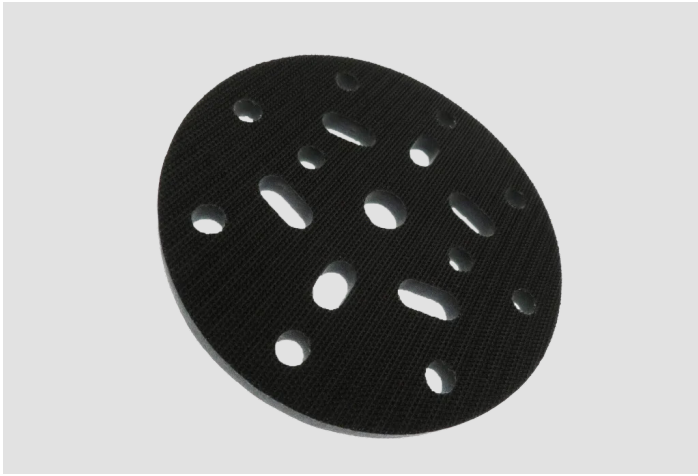

model: TW-BP6V2

thickness: 5/10mm

size: 150mm

Number of holes: 17 holes

Material: sponge

Constructed of soft durable sponge which allows the technician to follow contours and get closer to edges while minimizing burn through



model: TW-BP6V1

thickness: 3mm

size: 150mm

Number of holes: 52 holes

Material: sponge

Constructed of soft durable sponge which allows the technician to follow contours and get closer to edges while minimizing burn through



■ Spray gun





TW-HP1.3V1

Standard Nozzle : Φ 1.3mm
 Optional Nozzle : Φ 1.3 Φ 1.7 Φ 2.0mm
 Operating Pressure: 2.0-3.5bar
 Pattern Width : 180-280mm
 Air Consumption : 3.0-3.9cfm
 Paint Capacity : 600cc Plstic Cup



TW-HP2.5-0003

Standard Nozzle : Φ 2.5mm
 Operating Pressure: 2.0-3.5bar
 Pattern Width : 180-280mm
 Air Consumption : 3.0-3.9cfm
 Paint Capacity : 600cc Plstic Cup



TW-HPGL-0002

Standard Nozzle : Φ 4.0mm
 Operating Pressure: 2.5-3.0bar
 Pattern Width : 180-280mm
 Air Consumption : 3.0-3.9cfm
 Paint Capacity : 680cc Plstic Cup

Dual action polisher

Recommend : ★★★★★

Eccentric polishing machines are widely used in machinery, automobiles, aviation, electronics and other industries, and are mainly used for surface treatment and polishing of metal parts



ion



Polisher

Dual action polisher

TW-CP720V2

frequency: 50/60Hz

Powerinput: 720W

voltage: 220-240VAC

Speed: 2100-5000r/min

Orbit:21mm/15mm

Backing Pad: 150mm

NoiselevelLpA:69 db(A)

G.W./N.W.:15/14KG

Carton Size :56*45*20cm/4pcs



TW-CP950V1

frequency: 50/60Hz

Powerinput: 950W

voltage: 220-240VAC

Speed: 1800-4800r/min

Orbit :12MM/15MM/21MM

Backing Pad:125mm/150MM

NoiselevelLpA:69 db(A)

G.W./N.W. : 15/14KG

Carton Size :52X14.8X15.7cm/4pcs



TW-CP710V6

frequency: 50/60 Hz
Power input: 710W
voltage: 220-240VAC
Speed: 4000-5500r/min
Orbit: 12mm
Backing Pad: 125mm
Noise level LpA: 69 db(A)
G.W./N.W.: 15/14KG
Carton Size: 56*45*20cm/4pcs



TW-CP720V4

frequency: 50/60 Hz
Power input: 720W
voltage: 220-240VAC
Speed: 4000-5500r/min
Orbit: 21mm
Backing Pad: 150mm
Noise level LpA: 69 db(A)
G.W./N.W.: 15/14KG
Carton Size: 51* 33* 30cm/4pcs



Polisher

Dual action polisher

TW-CP650V1

frequency: 50/60 Hz

Power input: 650W

voltage: 220-240VAC

Speed: 2000-6400r/min

Orbit: 9mm

Backing Pad: 125/150mm

Noise level LpA: 69 db(A)

G.W./N.W.: 13/14KG

Carton Size: 34*13*15cm/4pcs



TW-CP1100V4

frequency: 50/60 Hz

Power input: 1100W

voltage: 220/110VAC

Speed: 2000-4800r/min

Orbit: 15mm

Backing Pad: 150mm

Noise level LpA: 69 db(A)

G.W./N.W.: 21/20KG

Carton Size: 49*17*14cm/6pcs



TW-CP710V4

frequency: 50/60 Hz

Powerinput: 710W

voltage: 220/110VAC

Speed: 2000-5500r/min

Orbit:10mm

Backing Pad: 75/100mm

Noise level LpA: 69 db(A)

G.W./N.W.:17/16KG

Carton Size:44 * 39 * 30cm/6pcs



TW-CP710V3

frequency: 50/60 Hz

Powerinput: 710WW

voltage: 220/110VAC

Speed: 2000-5000r/min

Orbit:12mm

Backing Pad: 150mm

Noise level LpA: 69 db(A)

G.W./N.W.:18/17KG

Carton Size:44*39*30cm/6pcs



Polisher

Dual action polisher

TW-CP750V4

frequency: 50/60 Hz

Power input: 750W

voltage: 230VAC

Speed: 2000-6400r/min

Orbit: 9mm

Backing Pad: 150mm

Noise level LpA: 69 db(A)

G.W./N.W.: 18/17KG

Carton Size: 48.5*38*33cm/6pcs



TW-CP810V1

frequency: 50/60 Hz

Power input: 810W

voltage: 220/110VAC

Speed: 1650-4800r/min

Orbit: 21mm

Backing Pad: 150mm

Noise level LpA: 69 db(A)

G.W./N.W.: 16/15KG

Carton Size: 51.5*30*28cm/4pcs



TW-CP950V1

frequency: 50/60 Hz

Power input: 950W

voltage: 220/110VAC

Speed: 3000-5000r/min

Orbit:15mm

Backing Pad :125mm

Noise level LpA:69 db(A)

G.W./N.W.:17/16KG

Carton Size :49*33*31cm/4pcs



TW-CP750V1

frequency: 50/60 Hz

Power input: 750W

voltage: 220/110VAC

Speed: 3000-5500r/min

Orbit:12mm

Backing Pad :75mm

Noise level LpA:69 db(A)

G.W./N.W.:18/17KG

Carton Size :48.5*38*33cm/6pcs



Polisher

Dual action polisher

TW-CP750V2

frequency: 50/60 Hz

Powerinput: 750W

voltage: 220-240VAC

Speed: 2000-6400r/min

Orbit: 9mm

Backing Pad: 150mm

Noise level LpA: 69 db(A)

G.W./N.W.: 18/17KG

Carton Size: 48.5*38*33cm/4pcs



TW-CP1000V2

frequency: 50/60 Hz

Powerinput: 1000W

voltage: 220-240VAC

Speed: 3000-5200/3000-4800r/min

Orbit: 15/21mm

Backing Pad: 125/150mm

Noise level LpA: 69 db(A)

G.W./N.W.: 15/14KG

Carton Size: 47.5*15.5*15.5cm/4pcs



TW-CP350V1

frequency: 50/60 Hz

Power input: 350W

voltage: 220/110VAC

Speed: 1600-3500r/min

Orbit:15mm

Backing Pad :95mm*2

Noise level LpA:69 db(A)

G.W./N.W.:17/16KG

Carton Size:53.5 *38.4 *43cm/4pcs



Polisher

Dual action polisher

TW-CP710V7

frequency: 50/60Hz

Powerinput: 710W

voltage: 220-240VAC

Speed: 4000-5500r/min

Orbit:12mm

Backing Pad: 75mm

Noise level LpA: 69 db(A)

G.W./N.W.: 15/14KG

Carton Size: 56*45*20cm/4pcs



TW-CP1280WV1

frequency: 50/60Hz

Powerinput: 1280W

voltage: 220-240VAC

Speed: 2000-6000r/min

Orbit: 15mm

Backing Pad: 125mm

Noise level LpA: 69 db(A)

G.W./N.W.: 15/14KG

Carton Size: 56*45*20cm/4pcs







Rotary polisher

Spinner. It uses the heat generated by high-speed rotation to soften the paint surface, thereby removing scratches. However, this machine requires high operating skills and has certain risks. The working principle of the car polishing machine mainly relies on the motor to drive the polishing disc to rotate at high speed, working together with the polishing fabric, polishing liquid (polishing wax) and possible polishing agents to remove pollution, oxide layers, shallow marks and fine particles on the car paint surface. Scratches make the paint surface smooth and bright. During the polishing process, the polishing fluid can flow into the collection tray through a specific drain pipe, and the polishing cover and cover are used to prevent dust and other debris from falling on the polishing fabric when the machine is not in use, affecting the polishing effect.

Polisher

Rotary polisher

TW-CP1380V1

frequency: 50/60 Hz

Powerinput: 1380W

voltage: 220V

Speed: 1350~4500r/min

Output shaft threa: M10

Backing Pad: 100mm

Noise level LpA: 69 db(A)

G.W./N.W.: 17/18KG

Carton Size: 55* 41*23cm/8pcs



Polisher

Rotary polisher

TW-CP1200V6

frequency: 50/60 Hz

Powerinput: 1200W

voltage: 220-240VAC

Speed: 600-2100r/min

Orbit:21mm/15mm

Backing Pad: 150mm

Noise level LpA: 69 db(A)

G.W./N.W.: 15/14KG

Carton Size: 51* 33 * 30cm/4pcs



TW-CP1200V4

frequency: 50/60 Hz

Powerinput: 1200W

voltage: 220-240VAC

Speed: 1000-3000r/min

Backing Pad: 125MM

Noise level LpA: 69 db(A)

G.W./N.W. : 15/14KG

Carton Size: 53.5 * 35.5 * 31cm/4pcs



TW-CP1200V3

frequency: 50/60Hz
Powerinput: 1200W
voltage: 220/110VAC
Speed: 0-3000r/min
Backing Pad:180mm
Noise level LpA: 69 db(A)
G.W./N.W.:17/16KG
Carton Size:52*44*25.5cm/6pcs



TW-CP710V2

frequency: 50/60 Hz
Powerinput: 710WW
voltage: 220/110VAC
Speed: 1000-5000r/min
Backing Pad:40-125mm
Noise level LpA: 69 db(A)
G.W./N.W.:18/17KG
Carton Size:44*39*30cm/6pcs



Polisher

Rotary polisher

TW-CP750V3

frequency: 50/60Hz

Powerinput: 750W

voltage: 220-240VAC

Speed: 800-2100r/min

BackingPad: alternative'1''2''3'

Noise level LpA: 69 db(A)

G.W./N.W.: 17/16KG

Carton Size: 49*33*31cm/4pcs



TW-CP1200V1

frequency: 50/60Hz

Powerinput: 1200W

voltage: 220-240VAC

Speed: 300-2100r/min

BackingPad: 180MM

Noise level LpA: 69 db(A)

G.W./N.W. : 13/12KG

Carton Size: 47.5*31*30cm/4pcs



TW-CP1580V1

frequency: 50/60Hz
Powerinput: 1580W
voltage: 220/110VAC
Speed: 500-3000r/min
BackingPad:180mm
Noise level LpA:69db(A)
G.W./N.W.:17/16KG
Carton Size:56*38*26cm/4pcs



TW-CP1100V1

frequency: 50/60Hz
Powerinput: 1100W
voltage: 220/110VAC
Speed: 380-2100r/min
BackingPad:125/150mm
Noise level LpA:69db(A)
G.W./N.W.:18/17KG
Carton Size:49*17*14cm/6pcs



Cordless



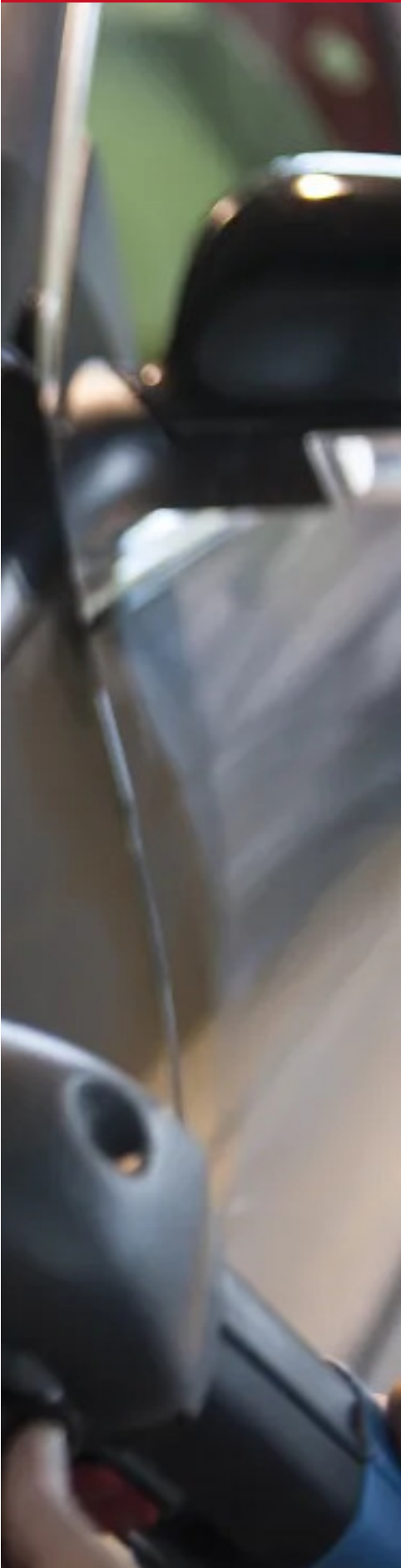

Lithium electric polishing machine

A lithium battery cordless polishing machine is a portable power tool used for polishing various surfaces such as automotive paint, metal, wood, and plastic. It utilizes a lithium-ion battery as its power source, providing convenience and mobility without the need for a power cord or external power supply. The lithium battery technology offers several advantages for cordless polishing machines.

When using a lithium battery cordless polishing machine, it's important to consider the battery capacity and runtime, as well as the charging time. Higher-capacity batteries will provide longer runtime between charges, while shorter charging times allow for quicker turnaround when the battery is depleted.

Polisher

Lithium battery cordless polishing machine

TW-LWM12V3

Voltage: 12V

Amperage: 2.0A

Current: 15A

Orbital range: 8mm

No-load speed: 2000-5000 r/min

Backing plate size: 125mm

Dimensions: 48×34×32cm

Noise level LpA: 69 db(A)

G.W./N.W.: 7/8KG



TW-CP12V1

Voltage: 12V

Amperage: 2.5A

Input power: 70W

Orbital range: 12mm

No-load speed: 4000-7000 r/min

Backing plate size: 75mm

Dimensions: 22x11x80cm

Noise level LpA: 69 db(A)

G.W./N.W.: 7/8KG



TW-CP18V1

Voltage: 18V

Amperage: 2.0A

No-load speed: :2000-5000r/min.

Orbital range: 3mm, 12mm & rotary

Backing plate size: 1-1/4 & 2inch

Dimensions: 29x11.5x5cm

Weight: 1.0kgs

Noise level LpA: 69 db(A)



TW-CP1000V2

Voltage: 10.8-12V

Rated current: 16A

Speed: 2000-5800r/min

Backing Pad: 30-75mm

Orbit: 8/12mm

Noise level LpA: 69 db(A)

G.W./N.W.: 13.3/12.6KG

Carton Size: 49.5*39.5*24.5cm/4pcs



Polisher

Lithium battery cordless polishing machine

TW-CP18V2

Voltage:18V

Amperage: 4.0A

Orbital range: 14mm

No-load speed: 2300-4800 r/min

Backing plate size: 125mm

Dimensions: 48×34×32cm

Noise level LpA: 69 db(A)

G.W./N.W.: 7/8KG



TW-CP36V1

Voltage:4VDC

Amperage: 2.0/3.0/4.0A

No-load speed: 1800 r/min

Backing plate size: 1 inch

Dimensions: 48×34×32cm

Noise level LpA: 69 db(A)

G.W./N.W.: 7/8KG



Cordless polishing machine



● TW-LWM12V4

Speed: 2500-5000rpm LCD display

Motor type: 4 pole motor

Battery: 12V, 2000mAh

EVA Pad Dia.: alternative 4'' 5'' 6''

Eccentric Distance: 4mm

Workingtime: about 35mins



● TW-LWM12V5

Speed: 2500-5000rpm LCD display

Motor type: 4 pole motor

Battery: 12V, 2600mAh

EVA Pad Dia.: 150mm (6'')

Eccentric Distance: 4mm

Workingtime: about 60mins



● TW-RC59-RC2607

Speed: 2500-5000rpm LCD display

Motor type: 4 pole motor

Battery: 12V, 2000mAh

EVA Pad Dia.: 150mm (6'')

Eccentric Distance: 8mm

Workingtime: about 35mins

◀◀ Flat velcro foam pad with stage

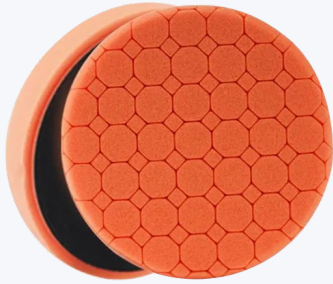

TW-tj150301

Material: american sponge
Color: orange with black velcro
Product size: 6"
Thickness: 3.0cm
Velcro size: 13.5cm
Function: Lightly chopped to medium coarse grind



TW-tj150302

Material: american sponge
Color: yellow with black velcro
Product size: 6"
Thickness: 3.0cm
Velcro size: 13.5cm
Function: medium polishing pad, hard

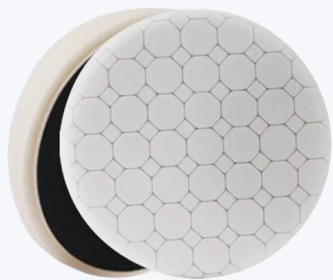

TW-tj150303

Material: american sponge
Color: white with black velcro
Product size: 6"
Thickness: 3.0cm
Velcro size: 13.5cm
Function: cutting foam polishing pad, hard



TW-tj150304

Material: German Foam
Color: black with black velcro
Product size: 6"
Thickness: 3.0cm
Velcro size: 13.5cm
Function: finishing pad, soft

Polisher pad

Flat velcro foam pad with stage

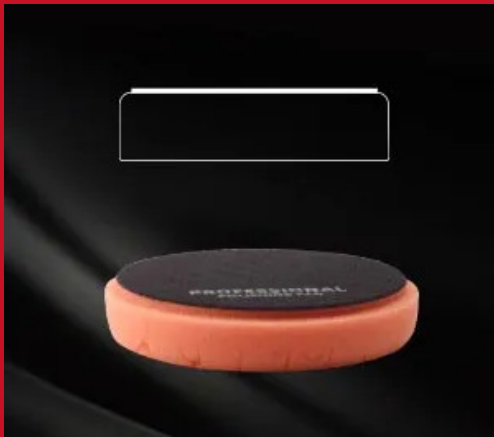

Material : american sponge

Color : orange with black velcro

Product size : 6"

Thickness : 3.0cm

Velcro size : 13.5cm

Function : Lightly chopped to medium coarse grind



Sponge plate series



Inch:	ItemNo:	Size:	Description:
6"	TW-150251	150*25	Dark red soft premium grade heavy cut and coarse grinding
6"	TW-150252	150*25	Orange Soft Premium Light Cut Medium Coarse Grind
6"	TW-150253	150*25	Blue Soft Premium Micro-Cut Medium-Fine Grind
6"	TW-150254	150*25	Green Soft Premium Medium Fine Polished Matt
6"	TW-150255	150*25	Black Soft Excellent Mirror Surface, Reduction, Polishing and Glazing Treatment
6"	TW-150256	150*25	White Soft Excellent Mirror Surface, Reduction, Polishing and Glazing Treatment
6"	TW-150257	150*25	Orange Medium Soft Premium Micro Cut Medium Fine Grind
6"	TW-150258	150*25	Yellow, medium soft, superior grade, micro-cut, medium-fine grinding
6"	TW-150259	150*25	Yellow Hard Premium Heavy Cut Coarse Grinding
6"	TW-1502510	150*25	Yellow Hard Premium Medium Cut Medium Coarse Grind
6"	TW-1502511	150*25	Maroon, hard, premium, medium cut, coarsely ground
5"	TW-125301	125*30	Gray Soft Excellent Mirror Surface, Reduction, Polishing and Glazing Treatment
5"	TW-125302	125*30	Orange Medium Hard Fine Light Cut Medium Coarse Grind
5"	TW-125303	125*30	White Medium Hard Fine Light Cut Medium Coarse Grind
5"	TW-125304	125*30	Black Chinese sponge polished
5"	TW-125305	125*30	Black soft Chinese sponge polished
5"	TW-125306	125*30	yellow soft china sponge polish
5"	TW-125307	125*30	Self-coloured medium-hard Chinese sponge polished
5"	TW-125308	125*30	Natural color soft china sponge polish
5"	TW-125309	125*30	Orange Medium Hard China Sponge Polish
5"	TW-125310	125*30	blue soft china sponge polish





Wool Polishing- Buffing Pads

Wool felt is soft and elastic and will not fall off easily. The sponge design is suitable for polishing uneven surfaces and is not easily deformed.



model: TW-wpbp01
size: 125/150mm
thickness: 20mm
Material: Brushed + sponge + wool
describe: finely ground



model: TW-wpbp02
size: 125/150mm
thickness: 20mm
Material: Brushed + sponge + wool
describe: medium to fine grind



model: TW-wpbp03
size: 125/150mm
thickness: 20mm
Material: Brushed + sponge + wool
describe: Coarse grinding



Wool Polishing- Buffing Pads

Wool felt is soft and elastic and will not fall off easily. The sponge design is suitable for polishing uneven surfaces and is not easily deformed.



model: TW-wpbp01
size: 125/150mm
thickness: 20mm
Material: Brushed + sponge + wool
describe: finely ground



model: TW-wpbp02
size: 125/150mm
thickness: 20mm
Material: Brushed + sponge + wool
describe: medium to fine grind



model: TW-wpbp03
size: 125/150mm
thickness: 20mm
Material: Brushed + sponge + wool
describe: Coarse grinding

双接口U盘

货号：ML90
品牌：云展数码
接口性质：云展网
颜色分类：黑色/白色



双接口U盘

货号：ML90
品牌：云展数码
接口性质：云展网
颜色分类：黑色/白色



双接口U盘

货号：ML90
品牌：云展数码
接口性质：云展网
颜色分类：黑色/白色



Collision Repair

汽车修复系列

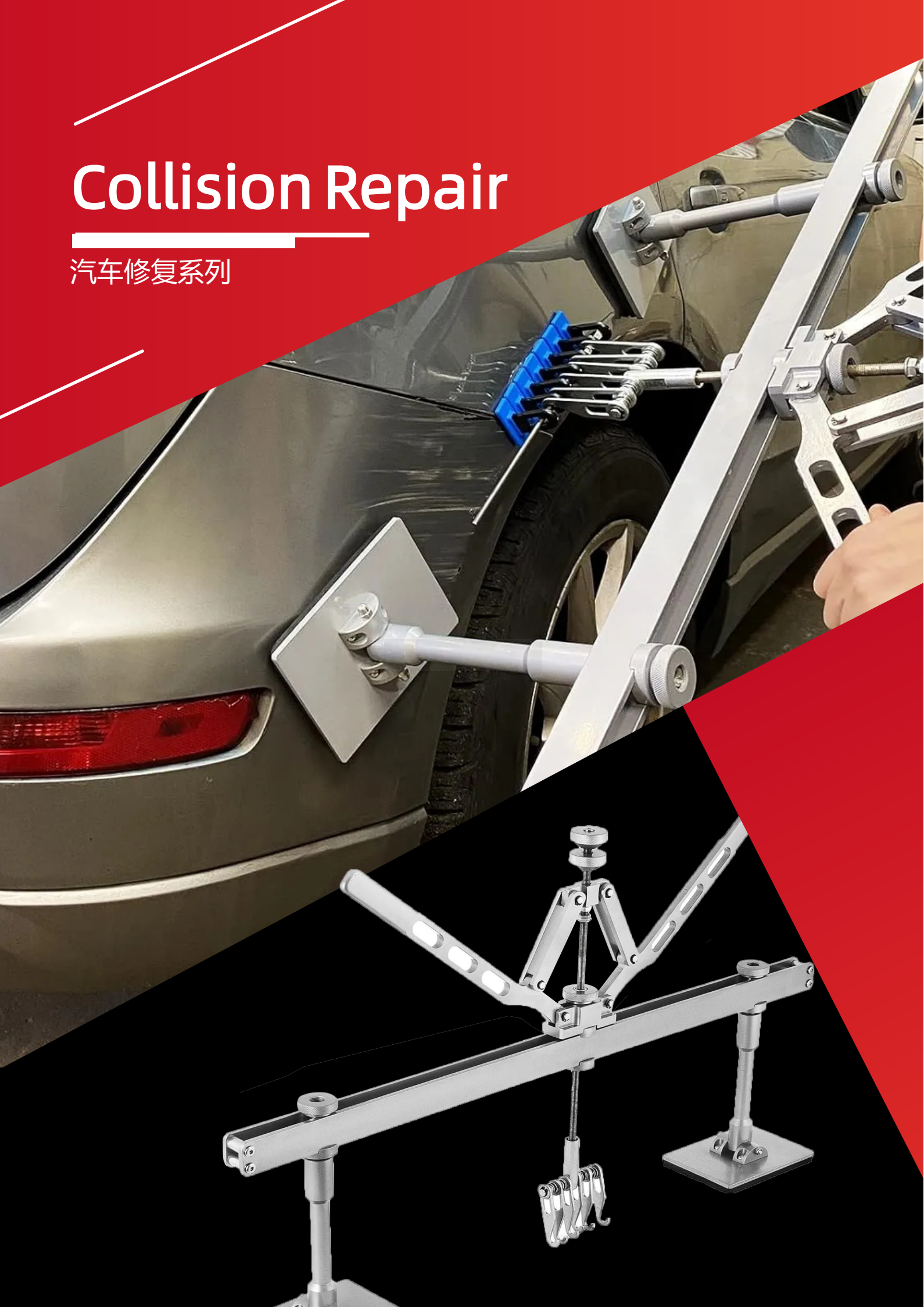

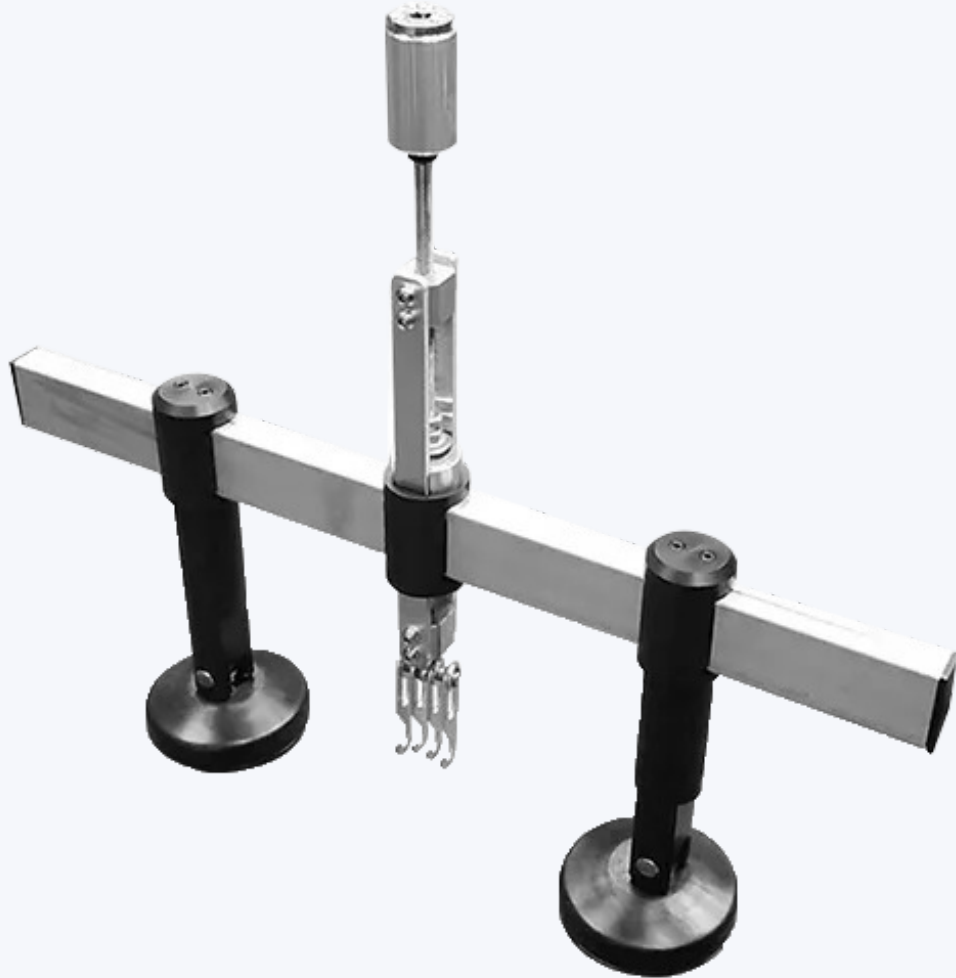

■ Car paint-free puller

- TW-PL600V1

Bridge puller (rotating double column round feet) total length 600mm/4 claws
Tool-free hand twisting, adjust the position, and don't slip off when you let go
High speed drawing automatic locking



application



application



application



Dent Repair Kit

TW-PL300V2

78-in-1 Professional-Grade Home Dent Repair Kit:

1x Professional hand pressure grapple puller

1x Texture fill light

1x red dent lifter

1x Lithium battery glue gun

1x battery pack

1x charger

1x dent ding hammer

1x Scrape Bar

10x blue car dent repair tabs

24x red Hybrid Tab Kit

3x Orange Dent Strips

14x Black Sliders

1x Dent Removal Tool

1x canvas bag

1x towel

1x yellow plastic spatula

5x black glue sticks

5x yellow glue sticks

1x bottle of alcohol (alcohol not included)

Repair tools



TW-WG003

Product name: Lithium battery plastic welding gun

Voltage: DC 21V

Battery: 1500mA*5 cells

Power: 90W-150W

High-end plastic box packaging contains: a welding gun, a charger, a battery, a pair of scissors, a knife, 50 large wavy nails, 50 small wavy nails, 50 M-shaped nails, V-shaped nails 50 nails + 1 small trowel



TW-SWG001

voltage: 220V 50Hz

Max. power: 2000W

output current: 500-800A

peak current: 1500A

output voltage: 4.5V

welding thickness; 0.2-1.0mm

welding time: 0-3 second (adjustable)

Heat gun



■ TW-HG600T3

Name: Ten-level temperature-adjustable brushless hot air gun
Working voltage: 220/50Hz
Power consumption: 1800W
Temperature display: none
Temperature range/display: 60-600°C
Temperature adjustment method: ten-level temperature adjustment by the top knob
Air volume: 150-450 liters/minute
Switch: two-speed adjustable wind speed
Shell material: two-color injection molded TPE rubber
Plastic PP+30% fiber
Motor: Brushless motor
Heating cylinder: chromium-plated iron material
Heating core: golden mica plate insulated heating core
Power cord: "Pure copper rubber power cord 2 meters including the leakage part connected to the machine 1.8 meters 2*1.0mm²"



■ TW-HG600T3

Name: hot air gun
voltage: 230/50Hz
Power consumption: 1000/2000W
Temperature display: none
Temperature range: 60-600°C
Air volume: 300/500 liters/minute
Switch: two-speed adjustable wind speed
Shell material: black injection molded TPE
Heating cylinder: chromium-plated iron material
Power cord: "Pure copper rubber power cord 2 meters including the leakage part connected to the machine 1.8 meters 2*1.0mm²"

Car Cleaning

汽车清洁系列



CAR WASHING MACHINE

▶ 汽车清洗机



TW-HPW1200V2

Vol:220-240V
Frequency: 50Hz/60Hz
Power: 1200w
Rated pressure:60bar
Max Pressure:90bar
Rated flow: 5.5L/min
Max flow: 6.5L/min
Motor type: carbon brush
Auto stop: YES
Power
Cord long: 5m



TW-HPW1600V1

Vol:220-240V
Frequency: 50Hz/60Hz
Power: 1600w
Rated pressure:90bar
Max Pressure:130bar
Rated flow: 6L/min
Max flow: 6.5L/min
Motor type: carbon brush
Auto stop: YES
Power
Cord long: 5m



The ultimate dirt fighter, the Tekway car wash is ideal for tackling a variety of light-to-medium duty cleaning jobs. Use it to clean boats, motorcycles, RV's, ATV's, trailers, decks, barbecues, siding and more.



Towel

毛巾

premium patented hybrid twist loop for drying your vehicle quickly. safely draws moisture away from the surface and into the patented twist/plush fiber design of the towel. one of the most absorbent towels by weight that we have ever

Microfiber cleaning cloths for cars are built to last. They are durable and long-lasting, and the reinforced edges prevent them from losing efficacy or shrinking after hundreds of washes. By choosing our towels, you not only reduce waste but also save money in the long run.



TW-T030

model: TW-T030 size: 30*30cm
Weight²: 200g color: 5 kinds



TW-T031

model: TW-T031 size: 35*35cm
Weight²: 250g color: 5 kinds



TW-T032

model: TW-T032 size: 30*30cm
Weight²: 300g color: 5 kinds



TW-T033

model: TW-T033 size: 30*30cm
Weight²: 200g color: 5 kinds



TW-T034

model: TW-T034 size: 30*30cm
Weight²: 200g color: 5 kinds



TW-T035

model: TW-T035 size: 30*30cm
Weight²: 300g color: 5 kinds



Car cleaning set

汽车清洁套组

Featuring a car detailing brush, drill brush, tire brush, microfiber wax applicator, cleaning mitt and more, our car detailing cleaning brush set contains everything you need to clean your car effectively. TEKWAY is your best choice!



TW-CCS19

model: TW-CCS19 size: custom made
 Specific Use: Car cleaning color: OEM
 Includes: Detail brush, round flat brush, wire brush, stainless steel brush, brass brush, nylon brush, vent brush, cleaning gloves, wax applicator, towel



TW-CCS25

model: TW-CCS25 size: custom made
 Specific Use: Car cleaning color: OEM
 Includes: Detail brush, round flat brush, wire brush, stainless steel brush, brass brush, nylon brush, vent brush, cleaning gloves, wax applicator, towel



TW-CCS23

model: TW-CCS23 size: custom made
 Specific Use: Car cleaning color: OEM
 Includes: Detail brush, round flat brush, wire brush, stainless steel brush, brass brush, nylon brush, vent brush, cleaning gloves, wax applicator, towel



TW-CCS25

model: TW-CCS25 size: custom made
 Specific Use: Car cleaning color: OEM
 Includes: Detail brush, round flat brush, wire brush, stainless steel brush, brass brush, nylon brush, vent brush, cleaning gloves, wax applicator, towel



